

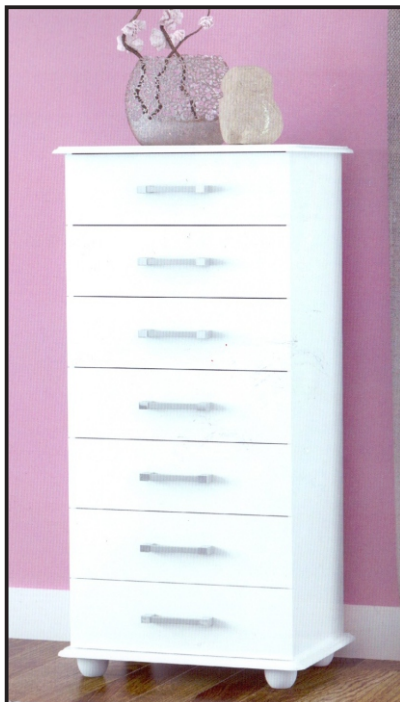

Rua: 26 de Dezembro, 326
Centro - CEP: 15155-000 - Jaci-SP
Fones: (17) 3283-1393 / 3283-1394 / 3283-1366
Fax: (17) 3283-1317
ejmoveis@ejmoveis.com.br
www.ejmoveis.com.br

INSTRUÇÃO DE MONTAGEM



Cômoda 7 Gavetas Grécia

DESEMBALANDO

Identifique todas as peças e deixe-as de pé, nunca coloque umas sobre as outras.
Utilize a própria embalagem como tapete para a montagem do produto.

PARA A LIMPEZA E CONSERVAÇÃO DO SEU MÓVEL













X Não use produto abrasivo como álcool, solventes, acetonas e etc...

✓ Use somente um pano macio e seco.

LISTA DE PEÇAS

Ref.		Descrição de Peças	Medida Pçs
01	07	Lateral Direita	1106x360x12
02	01	Lateral Esquerda	1106x360x12
03	07	Frente Gaveta	500x152x12
04	14	Lateral Gaveta	350x130x12
05	07	Contra Fundo Gaveta	437x100x12
06	01	Tampo	550x400x12
07	01	Base	550x400x12
08	07	Fundo de Gaveta	445x350x03
09	03	Fundo Traseiro	505x374x028
10	01	Travessa	485x900x15

LISTA DE ACESSÓRIOS

Nº	Acessórios	Qtd.	Nº	Acessórios	Qtd.
A	Cavilha 6 x 30 	40	G	Prego 12x12 	28
B	Parafuso 3,5 x 30 	04	H	Puxadores 	07
C	Parafuso 3,0 x 12 	120	I	Prego 8x8 	30
D	Parafuso 3,5 x 22 	14	J	Cantoneira Metálicas 	32
E	Sachet de Cola PVA 	02	K	Pés 	04
F	Parafuso 5,0 x 40 	04	L	Corrediças 	07 Pares

Passo 01

Atenção Sr. Montador: Antes da montagem do móvel, favor conferir os códigos dos acessórios na lista de acessórios.

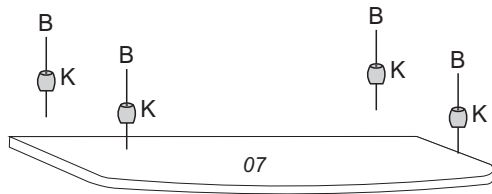

Passo 02

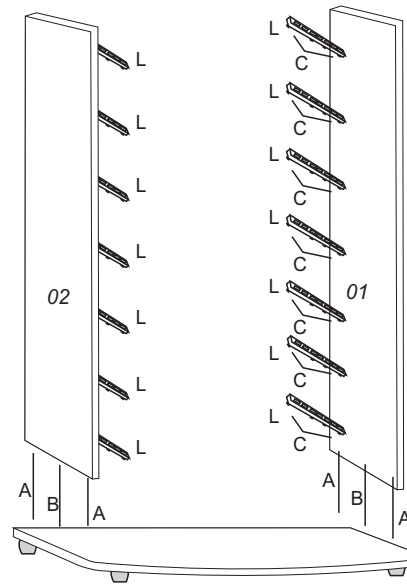

Passo 03

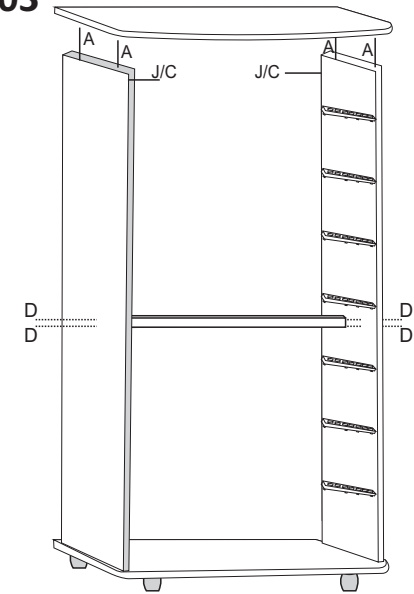

Passo 04 - Pregar os fundos usando prego (G)

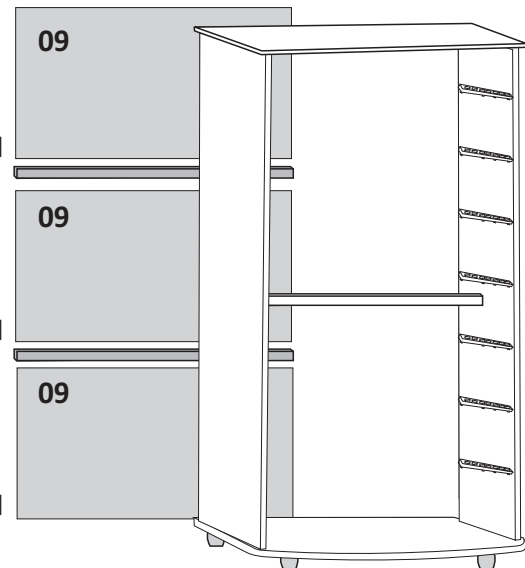

Passo 05 / Montar Gaveta

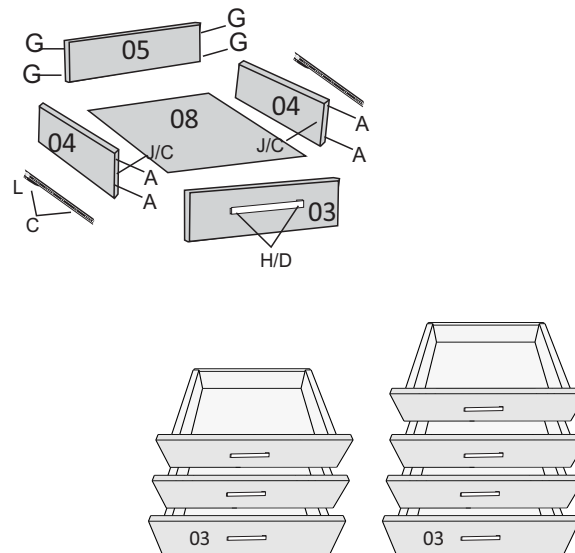

Móvel Pronto

