



EJMÓVEIS

Rua: 26 de Dezembro, 326
Centro - CEP: 15155-000 - Jaci-SP
Fones: (17) 3283-1393 / 3283-1394 / 3283-1366
Fax: (17) 3283-1317
ejmoveis@ejmoveis.com.br
www.ejmoveis.com.br

INSTRUÇÃO DE MONTAGEM



Mesa de Cabeceira Wood

DESEMBALANDO

Identifique todas as peças e deixe-as de pé, nunca coloque umas sobre as outras.

Utilize a própria embalagem como tapete para a montagem do produto.

PARA A LIMPEZA E CONSERVAÇÃO DO SEU MÓVEL

X Não use produto abrasivo como álcool, solventes, acetonas e etc...

✓ Use somente um pano macio e seco.

LISTA DE PEÇAS

Ref.	Qtd.	Descrição de Peças	Medida Pçs.	Mat.
01	01	BASE	435x360	Ag 12
02	01	LATERAL DIREITA	358x530	Ag 12
03	01	LATERAL ESQUERDA	358x530	Ag 12
04	01	TAMPO	435x360	Ag 12
05	03	RÉGUA DO BATENTE	396x052	Ag 12
06	03	RÉGUA INFERIOR	394x052	Ag 12
07	02	FUNDO TRASEIRO	275x420	MDF 2,8
08	03	FRENTE GAVETA	143x390	Ag 12
09	06	LATERAL GAVETA	325x080	Ag 12
10	03	CONTRA FUNDO	347x070	Ag 12
11	03	FUNDO GAVETA	325x357	MDF 2,8







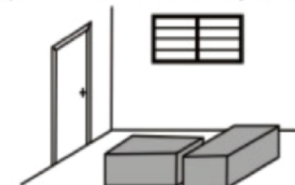



Utilize o papelão como proteção. Disponha as peças de modo prático.
Use el papel para protección. Ponga las piezas de manera práctica.
Use the cardboard as protection.
Arrange the pieces orderly.



Abra a Caixa no local de montagem.
Abra la caja en el local del montaje.
Open the box in the assembly locale.



LISTA DE ACESSÓRIOS

Nº	Acessórios	Qtd.	Nº	Acessórios	Qtd.
A	Cavilha 6 x 30 	38	G	Cantoneira Metálica 	16
B	Parafuso 5,0 x 40 	02	H	Prego 10 x 10 	30
C	Pés 	04	I	Prego 12 x 12 	12
D	Parafuso 7x50 Pés 	04	J	Sache de Cola 	01
E	Parafuso 3,5 x 35 Cabeça Chata 	06	K	Corrediças 	03 Pares
F	Parafuso 3,5x12 	56			

Passo 01

Atenção Sr. Montador: Antes da montagem do móvel, favor conferir os códigos dos acessórios na lista de acessórios.

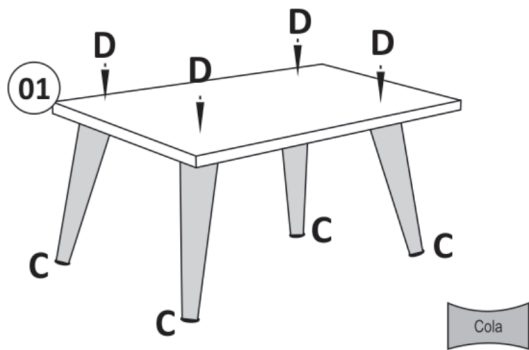

FIXAR OS PÉS (C) USANDO PARAF. (D)

Passo 02

FIXAR NAS LATERAIS 02/03 C/ PARAF. (F)
AS CORREIÇAS (K)
FIXAR AS LATERAIS 02/03 C/ PARAF. (B) + CAVILHA A

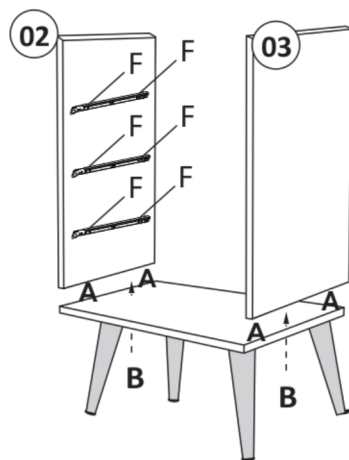

Passo 03

FIXAR NAS LATERAIS 02/03 C/
CAVILHA (A) JÁ UNIDAS AS
PEÇAS 05/06.

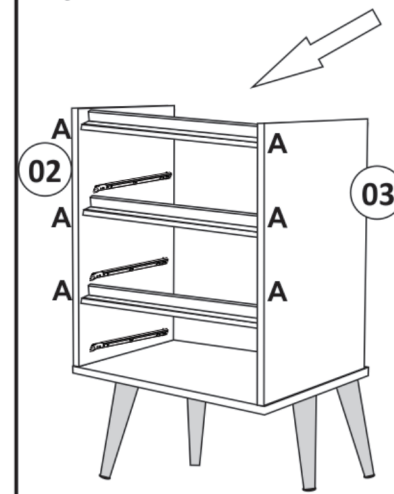
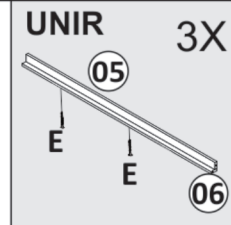

Passo 04 FIXAR O TAMPO (04) USANDO (F+G)



Suporte Angular



Suporte Angular



Passo 05

Vista Traseira
FIXAR OS FUNDOS (07)
USANDO PREGOS (H)

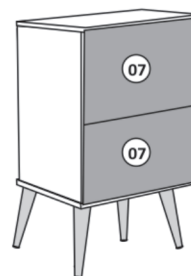

Montagem Gaveta



Suporte Angular

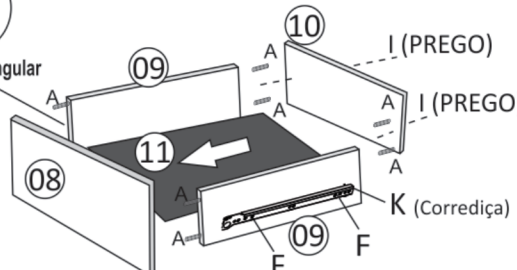

Móvel Pronto

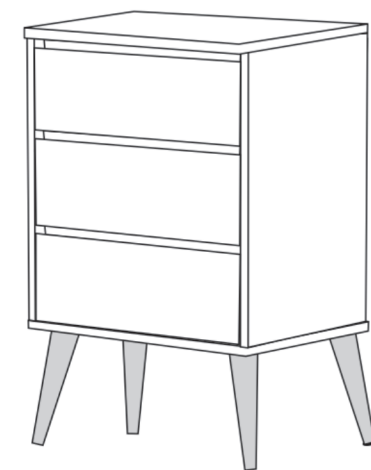

Altura: 710
Prof.: 360
Largura: 435